

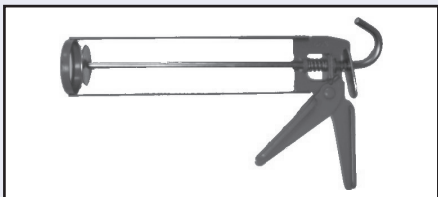

**PIPES, FLEXES,
TUBES, PASTE
& LUBRICANT**

Klarius™



Klarius N°: PST7AB
Re-usable Applicator for cartridge
(to be used with PST 6BW)



Klarius N°: PST6BW
Pack of 5 (500g) Cartridges of Asbestos - Free Manifold Paste
capable of withstanding extreme temperatures.

Klarius N°: PST8AD PST7AB applicator and pack of PST6BW paste cartridges



Klarius N°: PST4NB
Pack of 12 (140g) tubes of manifold paste



Klarius N°: PST3CK
Pack of 10 (250g) tubs of non-asbestos exhaust joining putty.
Gas tight and resistant to 1000°C.

CHROME TRIMS

Klarius polished Chrome Trim

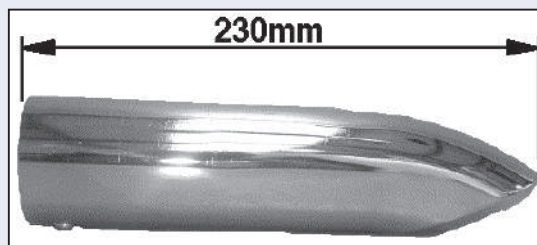
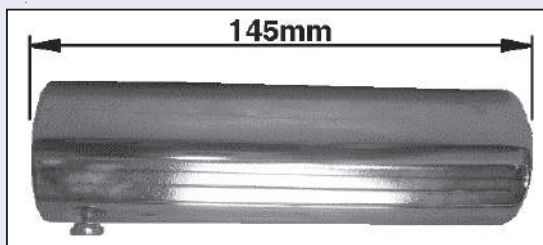

Klarius N°	Internal Bore of Trim	
TRM101AP	32mm	1 1/4"
TRM103AW	38mm	1 1/2"
TRM104AA	42mm	1 5/8"
TRM105AC	45mm	1 3/4"
TRM106AE	48mm	1 7/8"
TRM107AH	51mm	2"
TRM108AK	54mm	2 1/8"
TRM109AM	57mm	2 1/4"
TRM110AQ	60mm	2 3/8"

Klarius N°	Internal Bore of Trim	
TRM13AJ	38mm	1 1/2"
TRM14AL	42mm	1 5/8"
TRM15AP	45mm	1 3/4"
TRM16AT	48mm	1 7/8"
TRM17AW	51mm	2"
TRM18AA	54mm	2 1/8"

High quality polished Chrome Trims

Polished 3 times prior to chroming, Chrome to BS 1224 - 1970 specification

Rigid Steel Tubing

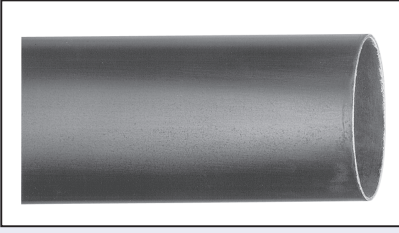

Klarius N°	Outside Dia.		Thickness
RST1C	25mm	1"	1.2mm
RST3A	32mm	1 1/4"	1.2mm
RST4X	35mm	1 3/8"	1.5mm
RST5W	38mm	1 1/2"	1.5mm
RST6V	41mm	1 5/8"	1.5mm
RST7T	44mm	1 3/4"	1.5mm
RST8Q	48mm	1 7/8"	1.5mm
RST9P	51mm	2"	1.5mm
RST10Q	54mm	2 1/8"	1.5mm
RST11P	57mm	2 1/4"	1.5mm

Klarius N°	Outside Dia.		Thickness
RST12M	60mm	2 3/8"	1.5mm
RST13L	64mm	2 1/2"	1.5mm
RST15J	70mm	2 3/4"	1.5mm
RST17G	76mm	3"	1.5mm
RST18E	79mm	3 1/8"	1.5mm
RST20C	89mm	3 1/2"	1.5mm
RST22A	102mm	4"	1.5mm
RST24W	114mm	4 1/2"	2.0mm
RST26T	127mm	5"	2.0mm

Supplied in 2metre lengths. Mild steel electric resistance welded tubing to BS 6323.

Flexible Tubing Copper Bonded

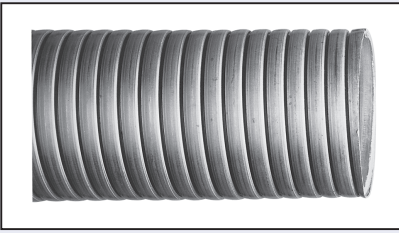

Klarius N°	Inside Dia.	
FCP1C	25mm	1"
FCP3A	32mm	1 1/4"
FCP4X	35mm	1 3/8"
FCP5W	38mm	1 1/2"
FCP6V	41mm	1 5/8"
FCP7T	44mm	1 3/4"
FCP8Q	48mm	1 7/8"
FCP9P	51mm	2"
FCP10Q	54mm	2 1/8"
FCP11P	57mm	2 1/4"
FCP12M	60mm	2 3/8"
FCP13L	64mm	2 1/2"

Klarius N°	Inside Dia.	
FCP14K	67mm	2 5/8"
FCP15J	70mm	2 3/4"
FCP17G	76mm	3"
FCP18E	79mm	3 1/8"
FCP19D	83mm	3 1/4"
FCP20C	89mm	3 1/2"
FCP25V	92mm	3 5/8"
FCP21B	95mm	3 3/4"
FCP22A	102mm	4"
FCP23X	108mm	4 1/4"
FCP24W	114mm	4 1/2"
FCP26T	127mm	5"

Supplied in 2metre lengths. Interfolded construction cannot be unravelled by twisting. High tensile strength and crush resistance. Galvanised mild steel

Flexible Tubing

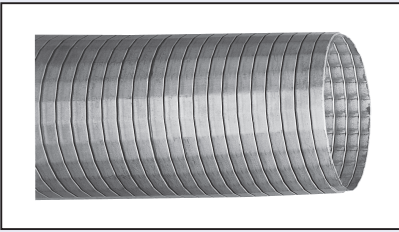

Polylock; Galvanised		
Klarius N°	Inside Dia.	
PLF3C	32mm	1 1/4"
PLF4B	35mm	1 3/8"
PLF5A	38mm	1 1/2"
PLF6X	41mm	1 5/8"
PLF7W	44mm	1 3/4"
PLF8V	48mm	1 7/8"
PLF9T	51mm	2"
PLF10W	54mm	2 1/8"
PLF11V	57mm	2 1/4"
PLF12T	60mm	2 3/8"
PLF13Q	64mm	2 1/2"
PLF14P	67mm	2 5/8"
PLF15M	70mm	2 3/4"
PLF17K	76mm	3"
PLF18J	79mm	3 1/8"
PLF19H	83mm	3 1/4"
PLF20G	89mm	3 1/2"
PLF25A	92mm	3 5/8"
PLF21E	95mm	3 3/4"
PLF22D	102mm	4"
PLF23C	108mm	4 1/4"
PLF24B	114mm	4 1/2"
PLF26X	127mm	5"

Supplied in 2 metre lengths.

Crimped interfolded construction Ensures that diameter remains constant when tubing is cut.

Stainless Steel Tubing

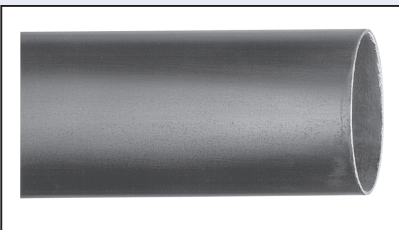

Klarius N°	Outside Dia.		Thickness
460235	38mm	1 1/2"	1.5mm
460236	42mm	1 5/8"	1.5mm
460237	45mm	1 3/4"	1.5mm
460238	50mm	2"	1.5mm
460239	54mm	2 1/8"	1.5mm
460240	57mm	2 1/4"	1.5mm
460241	60mm	2 3/8"	1.5mm

Supplied in 2metre lengths.

Exhaust Bends

Klarius N°	Outside Dia.		Bend Angle Φ
	mm	"	
430497	76mm	3"	30°
430498	89mm	2 1/2"	
430499	101.5mm	4"	
430500	114mm	4 1/2"	
430501	32mm	1 1/4"	45°
430502	35mm	1 3/8"	
430503	38mm	1 1/2"	
430504	42mm	1 5/8"	
430505	45mm	1 3/4"	
430506	48mm	1 7/8"	
430507	51mm	2"	
430508	54mm	2 1/8"	
430509	60mm	2 3/8"	
430510	76mm	3"	60°
430511	89mm	3 1/2"	
430512	101.5mm	4"	
430513	114mm	4 1/2"	
430514	32mm	1 1/4"	90°
430515	35mm	1 3/8"	
430516	38mm	1 1/2"	
430517	42mm	1 5/8"	
430518	45mm	1 3/4"	
430519	48mm	1 7/8"	
430520	51mm	2"	
430521	54mm	2 1/8"	
430522	57mm	2 1/4"	
430523	60mm	2 3/8"	
430524	64mm	2 1/2"	
430525	70mm	2 3/4"	
430526	76mm	3"	
430527	89mm	3 1/2"	
430528	101.5mm	4"	
430529	114mm	4 1/2"	

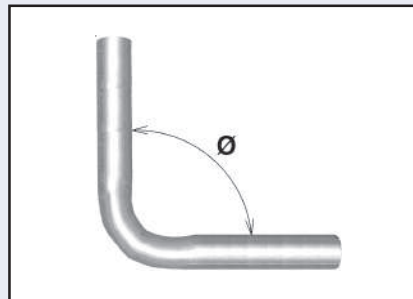
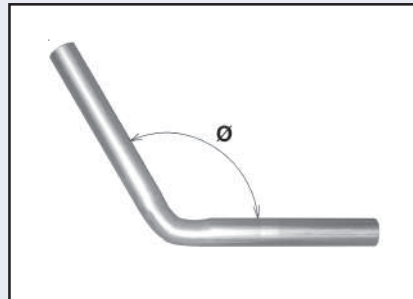
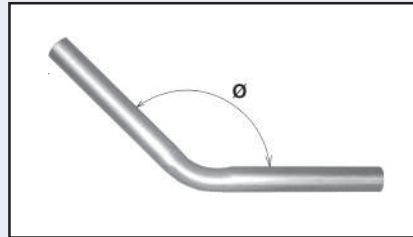
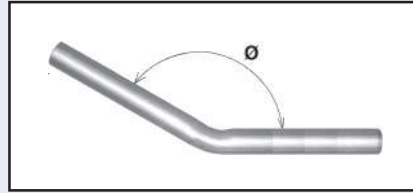

Flared Pipe Extensions

Klarius N°	Flare "ID2" mm	"ID" mm	"L"
430568	68.0	48.5	80
430569	66.0	50.5	95
430570	66.0	50.5	220
430571	70.0	50.5	80
430572	68.0	54.5	110
430573	70.0	54.5	120
430574	78.0	60.5	120

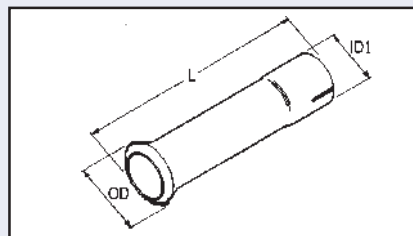
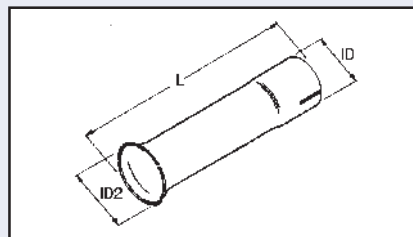

Klarius N°	Olive "OD" mm	"ID1" mm	"L"
430575	85.0	48.5	100
430576	73.0	54.5	100

Pipe Extensions

Klarius N°	ID mm	OD mm	Wall Thickness mm
430545	35.5	35	1.20
430546	38.5	38	1.20
430547	42.5	42	1.20
430548	43	43	1.20
430549	45.5	45	1.20
430550	48.5	48	1.50
430551	51.5	51	1.50
430552	55.5	54	1.50
430553	58.5	57	1.50
430554	60.5	60	1.50

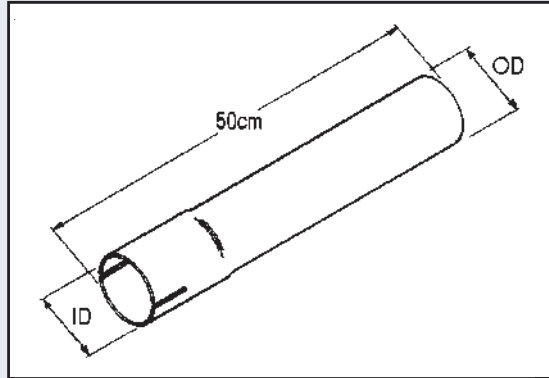

Connecting Pipe

Klarius N°	ID mm	OD mm	Wall Thickness mm
430555	35.5	35	1.20
430556	38.5	38	1.20
430557	42.5	42	1.20
430558	43	43	1.20
430559	45.5	45	1.20
430560	48.5	48	1.50
430561	51.5	50.8	1.50
430562	55.5	54	1.50
430563	58.5	57	1.50
430564	60.5	60	1.50

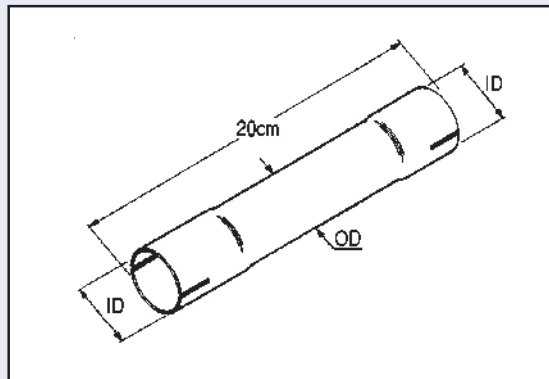

Reducing Bushes

Klarius N°	ID mm	OD mm	
430530	35.5	32.0	Without Slots
430531	38.5	35.0	Without Slots
430532	42.0	38.0	Without Slots
430533	45.0	41.5	Without Slots
430534	48.0	44.5	Without Slots
430535	50.5	47.5	Without Slots
430536	54.5	50.0	Without Slots
430537	58.0	54.0	Without Slots
430538	61.0	57.0	Without Slots
430539	64.0	60.0	With Slots
430544	43.0	45.0	With Slots
430540	45.5	50.5	With Slots
430541	48.5	50.0	With Slots
430542	50.5	50.0	With Slots
430543	54.5	50.0	With Slots

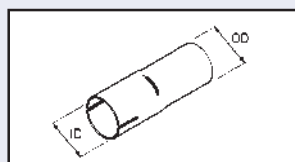
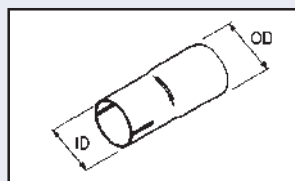
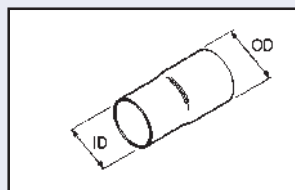

Flexible Repair Pipes

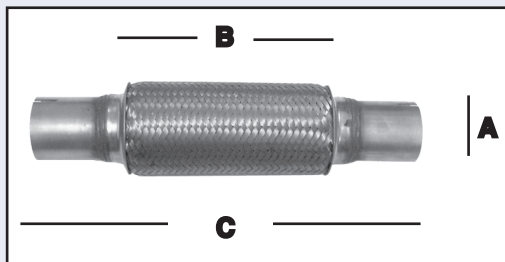

Klarius N°	A(ID) mm	B mm	C mm	Klarius N°	A(ID) mm	B mm	C mm
FRP1J	38.5	152	280	FRP12L	48.5	251	390
FRP2H	38.5	203	330	FRP13K	51.5	152	290
FRP3G	38.5	262	400	FRP14J	51.5	203	340
FRP4E	42.5	152	280	FRP15H	51.5	251	390
FRP5D	42.5	203	330	FRP16G	54.5	152	290
FRP6C	42.5	262	400	FRP17E	54.5	203	330
FRP7B	45.5	152	280	FRP18D	54.5	251	390
FRP8A	45.5	203	340	FRP19C	57.5	152	290
FRP9X	45.5	262	400	FRP20B	57.5	243	400
FRP10P	48.5	152	290	FRP21A	60.5	152	290
FRP11M	48.5	203	340	FRP22X	60.5	243	390

Connection Pipes

Standard (90 mm length)

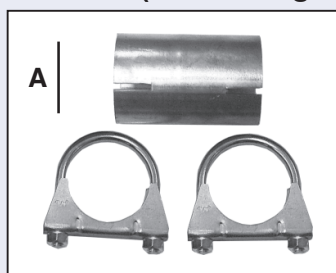

Klarius N°	A (ID) mm	Klarius N°	A (ID) mm
SLV1AE	38.5	SLV7AX	52.5
SLV2AH	40.5	SLV8AB	54.5
SLV3AK	42.5	SLV9AD	55.5
SLV4AM	45.5	SLV10AG	57.5
SLV5AQ	48.5	SLV11AJ	58.5
SLV6AV	50.5	SLV12AL	60.5

Deluxe



Klarius N°	A (ID) mm	A (OD) mm	Length mm	Klarius N°	A (ID) mm	A (OD) mm	Length mm
430462	43.0	46.7	80	430471	50.5	54.5	110
430463	43.0	46.7	90	430472	50.5	54.5	125
430464	43.0	46.7	125	430473	56.0	60.5	90
430465	45.0	49.5	80	430474	56.0	60.5	95
430466	45.0	49.5	90	430475	56.0	60.5	125
430467	46.0	50.5	125	430476	60.5	64.5	80
430468	50.5	54.5	80	430477	60.5	64.5	90
430469	50.5	54.5	90	430478	60.5	64.5	125
430470	50.5	54.5	95	430479	60.5	64.5	130

Emergency Repair Pipe

As used by leading motoring organisations.

Cut broken pipe & insert inside existing pipe. Tighten the bolt to expand & seal the unit. (A)

Can also be used when the pipe shears at the silencer (B).

Length approx 120mm

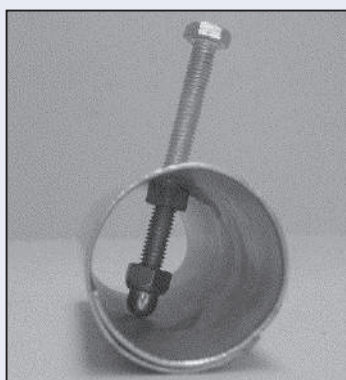

Klarius N°	Expansion mm
430449	28-32
430450	31-36
430451	35-41
430452	40-46
430453	45-53
430458	55-65

